

Article number: 204180M24100D3V

Description: E+G levelling foot
GN 41-80-M24-100-D3-V

Note: V Without nut, External hexagon at the top, Wrench flat at the bottom

Measures

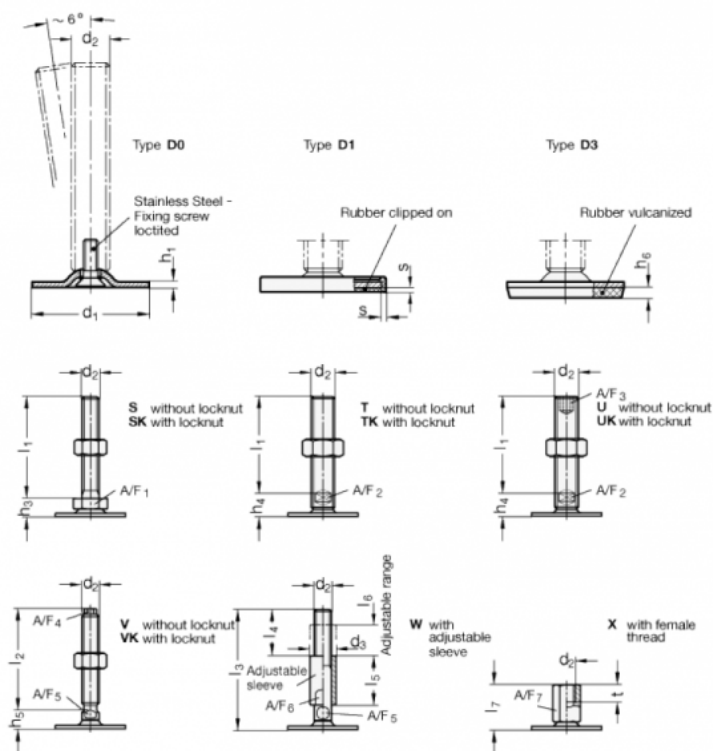

A/F4 = 17

s =

A/F5 = 20

d1 = 80

d2 = M24

h1 = 3

h5 = 18

h6 = 5

l2 = 100